

# Adaptive Digital Pre-Distortion (DPD)

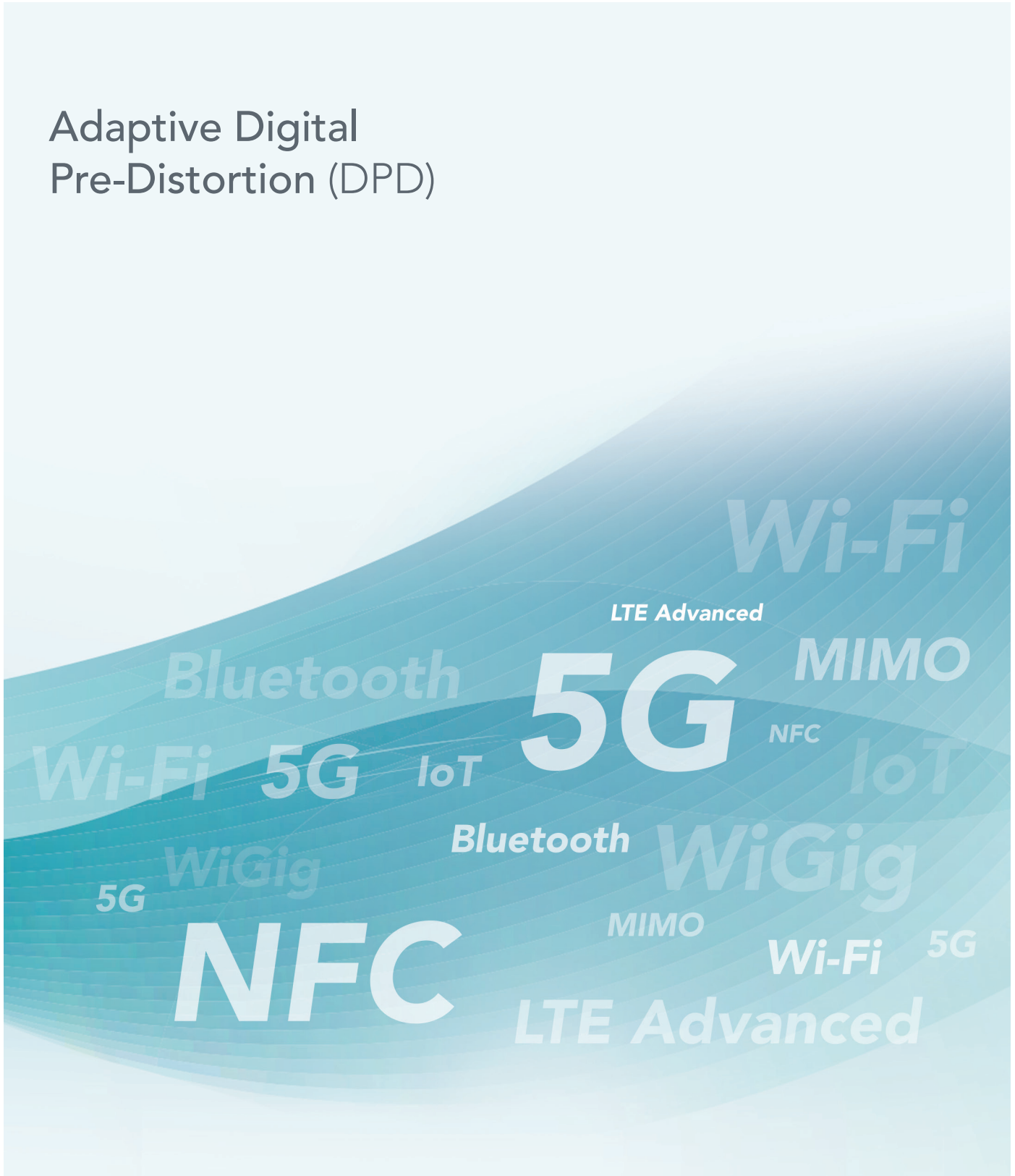

---

## Table of Contents

Overview of Adaptive DPD	2
Features and Specifications	2
Requirements	3
Adaptive DPD: Block Diagram	4
Adaptive DPD: High Level Flowchart	5
Crest Factor Reduction	6
Adaptive DPD Configuration Options	7
User Level Block Diagram and Calling Sequence	8
Example Code	9
DLL usage via zScript®	9
DLL usage via C++	9
DLL usage via Matlab®	9
General DPD Usage Guidelines and Best Practices	11
Noise Floor Correction via Time Domain Averaging	11
Convergence Time	11
Choosing the Number of DPD Training Iterations	11
Choosing the Baseband Signal Level	11
Impact of LO Leakage and Image on DPD Performance	11
Impact of Signal Chain on DPD Performance	12
Tips on designing a signal chain optimized for DPD	12
FAQ	12
What kind of power amplifiers does Adaptive DPD compensate nonlinearity for?	13
What is a typical operating range of a power level?	13
What is a typical power efficiency of power amplifiers used?	13
What is a typical ACLR achieved by Adaptive DPD?	13

## Overview of Adaptive DPD

Digital Pre-Distortion (DPD) is a software tool within the zScript test executive for power amplifier (PA) and front-end module (FEM) characterization and testing. DPD measures the nonlinearity of the PA, computes an inverse operation, and creates a pre-distorted RF signal that effectively linearizes the PA. In combination with the zSeries PA/FEM DVT Set, DPD is used to quantify improvements in spectral mask and Error Vector Magnitude (EVM) that will be possible with DPD in-circuit. Adaptive DPD supports PA/FEM testing for LTE cellular devices.

### Features and Specifications

Adaptive DPD is targeted towards cellular PA testing with upgraded testing capabilities:

- Adaptive learning step optimizes DPD engine for each specific PA architecture
- Multi-carrier testing with signal bandwidth up to 100 MHz
- Improves Adjacent Channel Leakage (power) Ratio (ACLR)
- Improves EVM
- Superior performance compared to standard GMP/LUT based DPD
- Crest Factor Reduction (CFR) algorithm achieves “close-to-minimum” EVM for target Peak-to-Average-Ratio (PAR)

### Requirements

Figure 1 shows a block diagram of a typical test setup for PA testing with DPD using equipment from LitePoint.

The typical equipment list includes:

- Vector Signal Generator (VSG), such as z8751
- Vector Signal Analyzer (VSA), such as z8651
- PXI/PXIe chassis and host computer
- Cables, directional coupler(s) and attenuator(s)
- Optional Power Meters
- Optional Arbitrary Waveform Generator (AWG)

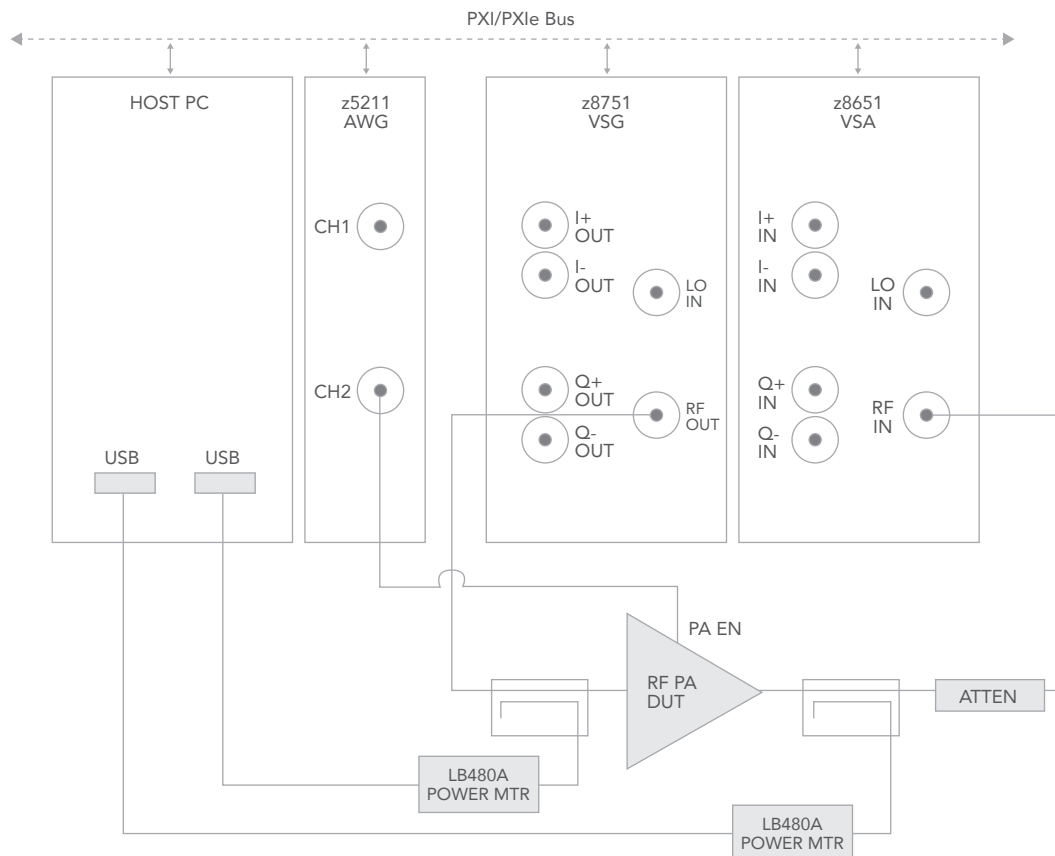
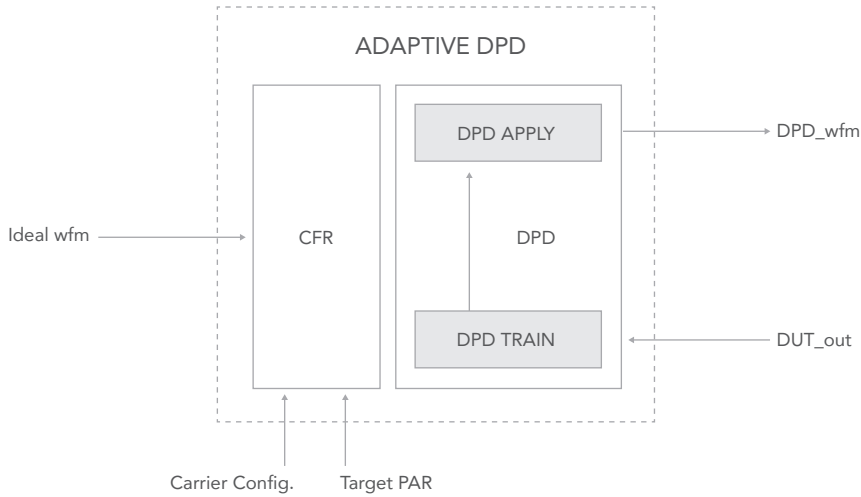

Figure 1. Test equipment block diagram for PA testing

## Adaptive DPD: Block Diagram

Adaptive DPD has three main building blocks:

1. Crest Factor Reduction (CFR): Lowers Peak-to-Average Ratio (PAR) of the signal while maintaining spectral properties intact
2. DPD Apply: Applies pre-distortion to the reference waveform
3. DPD Train: Updates DPD Engine coefficients based on feedback from the PA output.  
Updated coefficients are computed using a robust adaptation engine



## Adaptive DPD: High Level Flowchart

A high-level usage scenario for the blocks in Adaptive DPD.

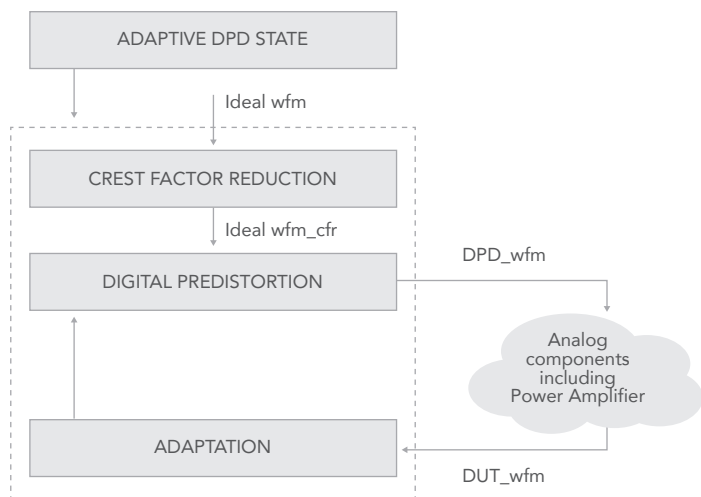

## Crest Factor Reduction

The Crest Factor Reduction algorithm lowers the Peak-to-Average-Ratio (PAR) of the input signal causing a minimal damage to the signal while maintaining the frequency domain properties intact. The algorithm supports both contiguous and non-contiguous carrier aggregation scenarios. Crest Factor Reduction, included with Adaptive DPD, is implemented via a proprietary “Clipping and Filtering” algorithm which achieves close-to-minimum EVM for target PAR. Figure 2 shows the signal at various stages of the algorithm. Figure 3 exhibits EVM vs PAR for a 40 MHz LTE signal constructed with 2x20 MHz LTE signals.

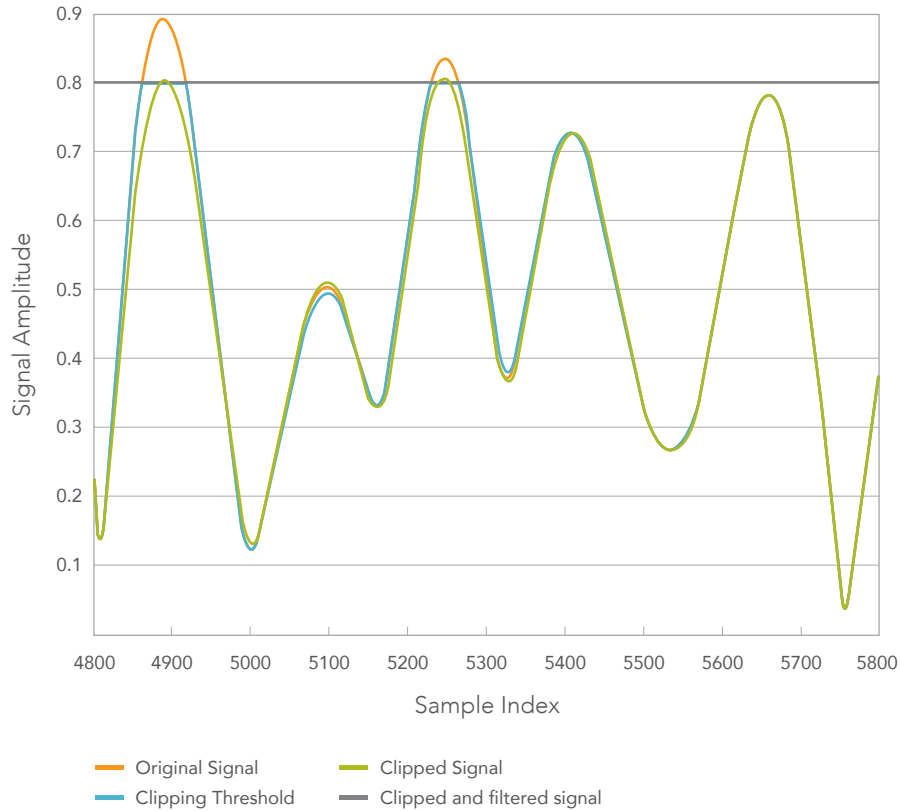

Figure 2. Signal at various stages of Crest Factor Reduction (CFR) Algorithm

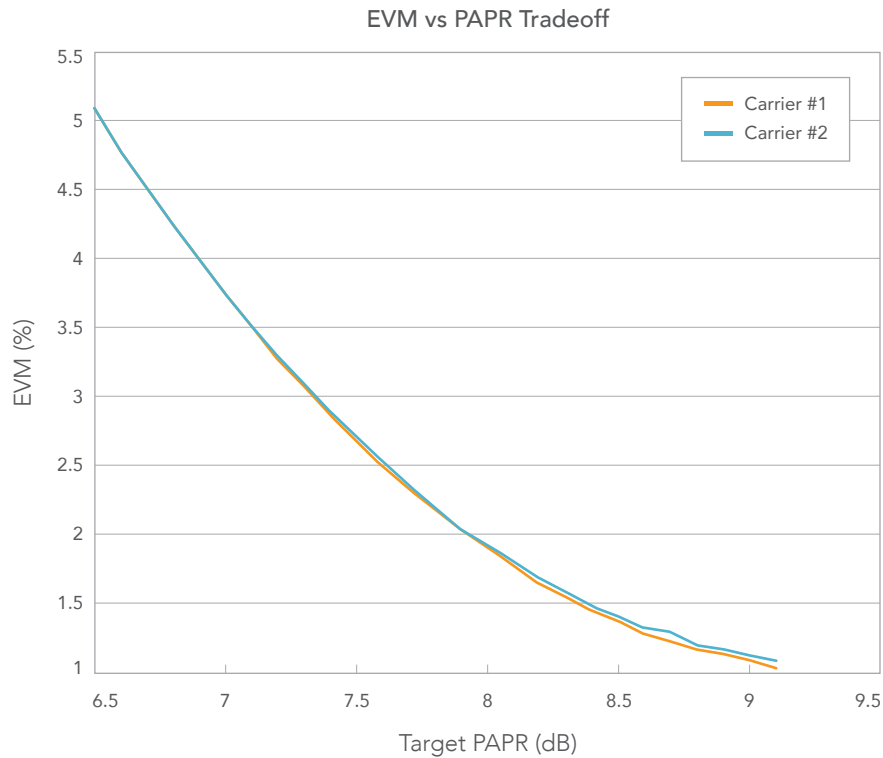

Figure 3. EVM vs PAR tradeoff for a 40 MHz LTE signal constructed with 2x20 MHz LTE signals

## Adaptive DPD Configuration Options

The main options that the user sets to configure Adaptive DPD are:

- DPD performance level (0 through 3, increasing performance with number)
- Target peak to average power ratio (PAR) for CFR algorithm
- Number of samples used for training. Typically, 20,000 samples are sufficient to reach good performance. Generally, DPD performance improves with an increasing number of training samples. The user is encouraged to increase/decrease the number to see impact on performance and execution time.
- Robustness coefficient: this is typically set to 0.001. The recommended range of robustness coefficient is between 0.0000001 and 1. The default value is sufficient for most of the testing scenarios, but some corner cases may require the user to increase the robustness coefficient. An increase in robustness may come at the price of performance. Typically for signal bandwidths of 60 MHz and above, set robustness coefficient to 0.1; and for signal bandwidths below 60 MHz, set robustness coefficient to 0.001.

## User Level Block Diagram and Calling Sequence

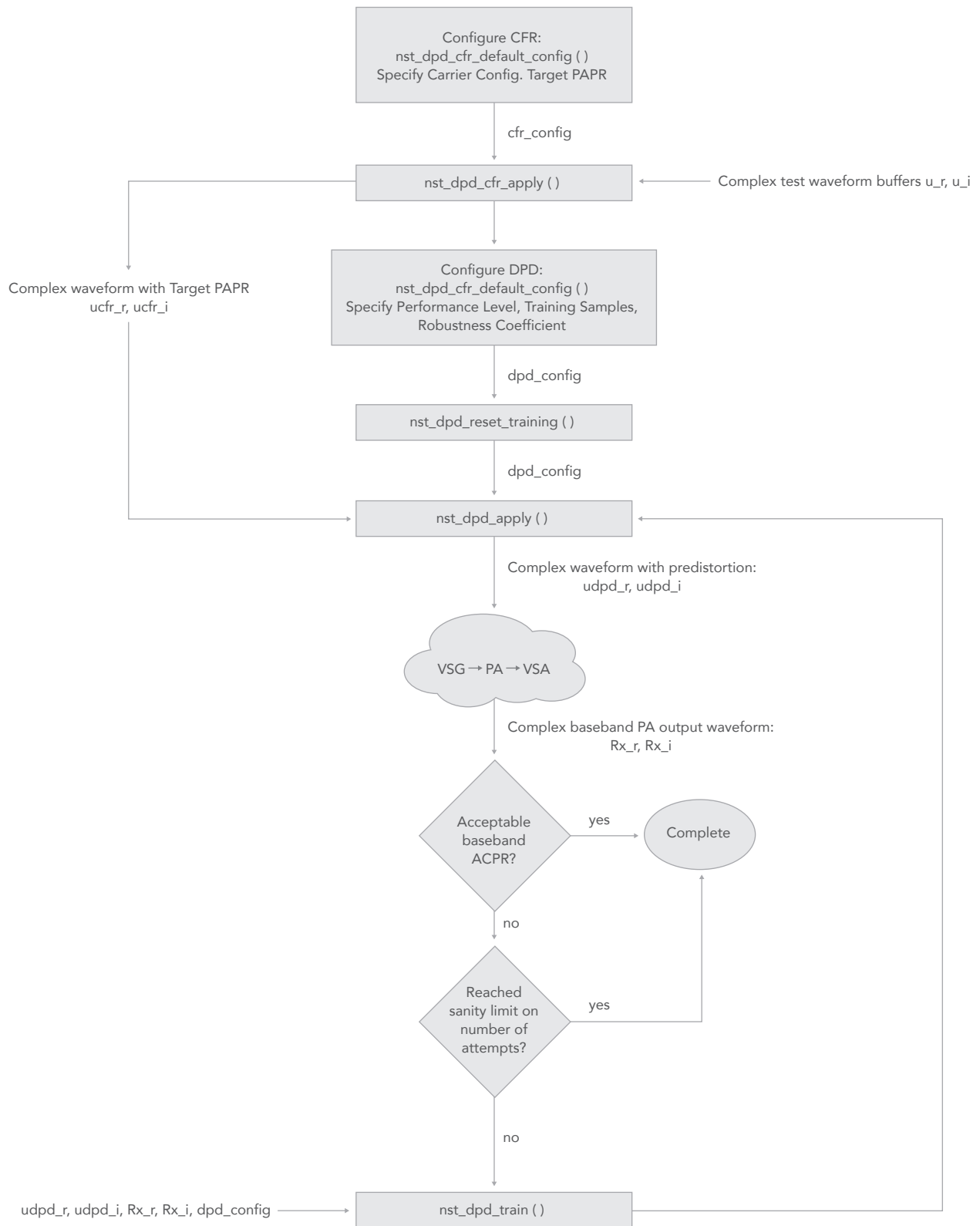

## Example Code

Please consult the example code to get started with using the DLL. The following code initializes the hardware and assumes a unity gain from the VSG to VSA. Connect the LitePoint Equipment in transceiver loopback mode to ensure the following code is working properly.

### DLL usage via zScript®

Provided in example\_adaptive\_DPD.csv

### DLL usage via C++

Provided in example\_adaptive\_DPD.cpp

### DLL usage via Matlab®

Provided in example\_adaptive\_DPD.m

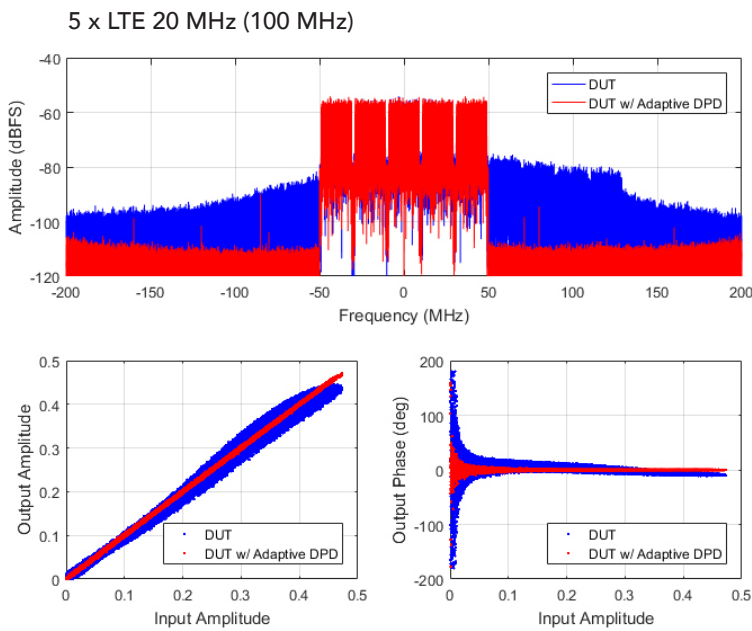

Figure 4. Sample plot generated by Matlab® example code with a PA in the loop for a 100 MHz LTE signal with a 90 W power amplifier. Blue curves are without DPD while red curves are with Adaptive DPD signals

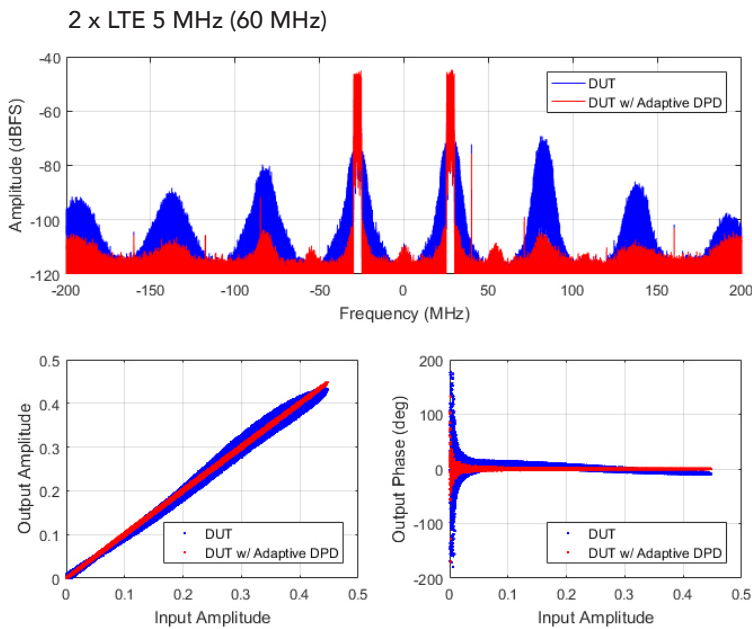

Figure 5. Sample plot generated by Matlab® example code with a PA in the loop for a 60 MHz LTE signal with a 90 W power amplifier. Blue curves are without DPD while red curves are with Adaptive DPD signals



---

## General DPD Usage Guidelines and Best Practices

### Noise Floor Correction via Time Domain Averaging

If noise floor of the signal chain is limiting the DPD performance, Noise Floor Correction is recommended. This can be accomplished by reading in multiple periods of the test waveform from the VSA, and then averaging them in the baseband time-domain. The resulting waveform will have a lowered noise floor.

### Convergence Time

Adaptive DPD may take multiple iterations to converge to good performance. Typical factors impacting the number of iteration to converge include:

- Number of training samples: a larger number of training samples results into fewer number of iterations to converge
- DPD performance level: a higher level DPD may take more iterations to converge compared to lower level DPD

### Choosing the Number of DPD Training Iterations

Training the Adaptive DPD is an iterative process - each time the DPD is trained, its effectiveness as a linearizer as measured, for example, by ACPR at the PA output improves. The user controls the number of training iterations and can choose to favor best performance (more iterations) or shortest runtime (fewer iterations). Typically the DPD performance converges after ~5 iterations.

### Choosing the Baseband Signal Level

Baseband signal level (expressed as dB in reference to Full Scale or dBFS) must be chosen carefully. A large baseband amplitude, say close to 0 dBFS, may warrant a high SNR but will not leave any headroom for DPD expansion. Conversely, a very small baseband amplitude, say -30 dBFS will result into a lower SNR. The recommended range of baseband amplitude is between -10 to -6 dBFS.

### Impact of LO Leakage and Image on DPD Performance

DPD performance in terms of ACLR and EVM may degrade in the presence of strong LO leakage or strong image. This is because the nonlinear interaction of the LO leakage and image with the test signal may create undesired frequency components. DPD best practices recommends that the user ensure that transmitter is operating with calibrated LO leakage and IQ mismatch. The following steps must be taken to ensure that LO leakage and image are not causing DPD performance degradation:

1. Apply a signal with offset frequency in baseband
2. Observe the level of image and LO leakage in reference to power in the test signal
3. Calibrate the signal chain for LO leakage and IQ mismatch.

It is recommended that the image and LO leakage levels are below -50 dBc

4. Run DPD.

### Impact of Signal Chain on DPD Performance

A poorly designed signal chain can severely limit the performance of a DPD. The factors that may contribute towards a poor signal chain are:

- Components with a high noise figure. It is recommended to select components that lead to the highest overall SNR for the signal chain.
- Components with a large VSWR will cause standing waves to be created due to imperfect matching
- A component that is heavily compressed
- Ground bouncing may degrade performance. To eliminate this, make sure that the reference plane of all the power supplies are tied together
- EM fields interference could also lead to poor DPD performance. If the PA is radiating and putting out more than 10 W, it is recommended to shield the PA from the rest of the chain.

---

## Tips on designing a signal chain optimized for DPD

1. Ensure that noise from any given component is not limiting the performance
2. Ensure that no component is compressed beyond its rated power
3. Connect pads or isolators between ports that may have poor impedance matching
4. Isolate the power amplification stages by connecting attenuator pads or isolators
5. Signal chain loop gain should be close to 0 dB. For example, if the gain introduced by the amplifier stage is 40 dB, the PA output should be attenuated by 40 dB before connecting it to the VSA

## FAQ

### What kind of power amplifiers does Adaptive DPD compensate nonlinearity for?

- Semiconductor type: GaN, Si, GaAs
- Device type: HEMT, HBT, LDMOS
- Circuit type: Doherty, Class AB

### What is a typical operating range of a power level?

- $P_{out} = P_{SAT} - PAR$ ; where  $P_{SAT}$  is defined as 3 dB compression point of power level over the entire operating bandwidth, and PAR is peak-to-average ratio
- Although there's no limit to PA's output power, adaptive DPD has been verified on PA with output power up to 100 W (50 dBm)

### What is a typical power efficiency of power amplifiers used?

- Up to 60%

### What is a typical ACLR achieved by Adaptive DPD?

Typically, between -50 dBc to -65 dBc. Achievable performance depends on the signal chain design in addition to following factors

1. PA topologies and devices
2. Bandwidth of PA
3. Operating power level in relation to  $P_{SAT} - PAR$
4. Instantaneous bandwidth in relation to compensation bandwidth
5. DPD Level used. A higher DPD level yields higher performance
6. Baseline transceiver performance
7. Quality of image and LO leakage correction

---

Adaptive DPD uses following 3rd party libraries. Respective license information is included.

**LAPACK/BLAS License:**

Copyright © 1992-2016 The University of Tennessee and The University of Tennessee Research Foundation. All rights reserved.

Copyright © 2000-2016 The University of California Berkeley. All rights reserved.

Copyright © 2006-2016 The University of Colorado Denver. All rights reserved.

Redistribution and use in source and binary forms, with or without modification, are permitted provided that the following conditions are met:

- Redistributions of source code must retain the above copyright notice, this list of conditions and the following disclaimer.
- Redistributions in binary form must reproduce the above copyright notice, this list of conditions and the following disclaimer listed in this license in the documentation and/or other materials provided with the distribution.
- Neither the name of the copyright holders nor the names of its contributors may be used to endorse or promote products derived from this software without specific prior written permission.

The copyright holders provide no reassurances that the source code provided does not infringe any patent, copyright, or any other intellectual property rights of third parties. The copyright holders disclaim any liability to any recipient for claims brought against recipient by any third party for infringement of that parties intellectual property rights.

THIS SOFTWARE IS PROVIDED BY THE COPYRIGHT HOLDERS AND CONTRIBUTORS "AS IS" AND ANY EXPRESS OR IMPLIED WARRANTIES, INCLUDING, BUT NOT LIMITED TO, THE IMPLIED WARRANTIES OF MERCHANTABILITY AND FITNESS FOR A PARTICULAR PURPOSE ARE DISCLAIMED. IN NO EVENT SHALL THE COPYRIGHT OWNER OR CONTRIBUTORS BE LIABLE FOR ANY DIRECT, INDIRECT, INCIDENTAL, SPECIAL, EXEMPLARY, OR CONSEQUENTIAL DAMAGES (INCLUDING, BUT NOT LIMITED TO, PROCUREMENT OF SUBSTITUTE GOODS OR SERVICES; LOSS OF USE, DATA, OR PROFITS; OR BUSINESS INTERRUPTION) HOWEVER CAUSED AND ON ANY THEORY OF LIABILITY, WHETHER IN CONTRACT, STRICT LIABILITY, OR TORT (INCLUDING NEGLIGENCE OR OTHERWISE) ARISING IN ANY WAY OUT OF THE USE OF THIS SOFTWARE, EVEN IF ADVISED OF THE POSSIBILITY OF SUCH DAMAGE.

**KissFFT License:**

Copyright © 2003-2010 Mark Borgerding. All rights reserved.

Redistribution and use in source and binary forms, with or without modification, are permitted provided that the following conditions are met:

- Redistributions of source code must retain the above copyright notice, this list of conditions and the following disclaimer.
- Redistributions in binary form must reproduce the above copyright notice, this list of conditions and the following disclaimer in the documentation and/or other materials provided with the distribution.
- Neither the author nor the names of any contributors may be used to endorse or promote products derived from this software without specific prior written permission.

THIS SOFTWARE IS PROVIDED BY THE COPYRIGHT HOLDERS AND CONTRIBUTORS "AS IS" AND ANY EXPRESS OR IMPLIED WARRANTIES, INCLUDING, BUT NOT LIMITED TO, THE IMPLIED WARRANTIES OF MERCHANTABILITY AND FITNESS FOR A PARTICULAR PURPOSE ARE DISCLAIMED. IN NO EVENT SHALL THE COPYRIGHT OWNER OR CONTRIBUTORS BE LIABLE FOR ANY DIRECT, INDIRECT, INCIDENTAL, SPECIAL, EXEMPLARY, OR CONSEQUENTIAL DAMAGES (INCLUDING, BUT NOT LIMITED TO, PROCUREMENT OF SUBSTITUTE GOODS OR SERVICES; LOSS OF USE, DATA, OR PROFITS; OR BUSINESS INTERRUPTION) HOWEVER CAUSED AND ON ANY THEORY OF LIABILITY, WHETHER IN CONTRACT, STRICT LIABILITY, OR TORT (INCLUDING NEGLIGENCE OR OTHERWISE) ARISING IN ANY WAY OUT OF THE USE OF THIS SOFTWARE, EVEN IF ADVISED OF THE POSSIBILITY OF SUCH DAMAGE.

Copyright © 2017 LitePoint, A Teradyne Company.

All rights reserved

#### RESTRICTED RIGHTS LEGEND

No part of this document may be reproduced, transmitted, transcribed, stored in a retrieval system, or translated into any language or computer language, in any form or by any means, electronic, mechanical, magnetic, optical, chemical, manual, or otherwise, without the prior written permission of LitePoint Corporation.

#### DISCLAIMER

LitePoint Corporation makes no representations or warranties with respect to the contents of this manual or of the associated LitePoint Corporation products, and specifically disclaims any implied warranties of merchantability or fitness for any particular purpose. LitePoint Corporation shall under no circumstances be liable for incidental or consequential damages or related expenses resulting from the use of this product, even if it has been notified of the possibility of such damages.

If you find errors or problems with this documentation, please notify LitePoint Corporation at the address listed below. LitePoint Corporation does not guarantee that this document is error-free. LitePoint Corporation reserves the right to make changes in specifications and other information contained in this document without prior notice.

#### TRADEMARKS

LitePoint and the LitePoint logo are registered trademarks of LitePoint Corporation. zSeries is a trademark of LitePoint Corporation. All other trademarks or registered trademarks are owned by their respective owners.

#### CONTACT INFORMATION

LitePoint Corporation  
575 Maude Court  
Sunnyvale, CA 94085-2803  
United States of America

+1.866.363.1911

+1.408.456.5000

#### LITEPOINT TECHNICAL SUPPORT

[www.litepoint.com/support](http://www.litepoint.com/support)

Doc: 1075-0418-001

May 2017 Rev 1